

Article number: 0102030

Description: Retaining ring J14 DIN472
Spring steel

Measures

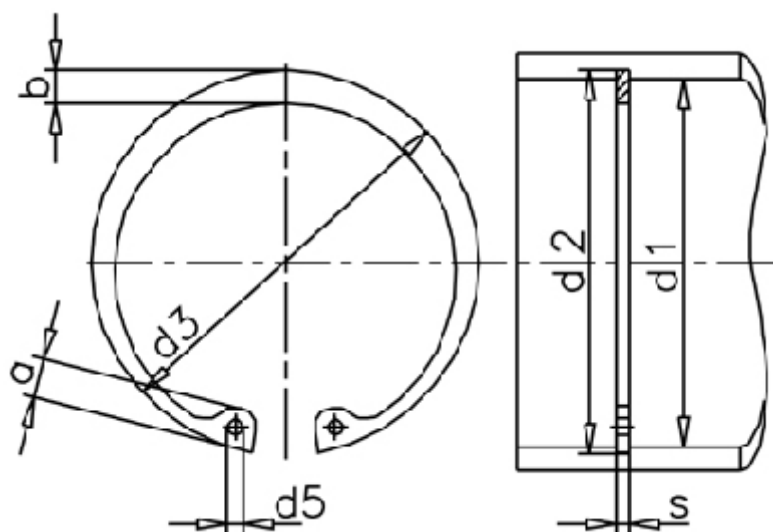

a max	= 3.7	FN kN	= 2.25	t	= 0.30
AN mm ²	= 13.4	FRg kN	= 2.3	tol	= +0,11
b	= 1.8	FR kN	= 4.5	tol	= +0,36-1,10
d1	= 14	g	= 0.5	tol	= -0.06
d2	= 14.6	K kN-mm	= 19.7	Tong	= ZGJ-1
d3	= 15.10	m min	= 1.10	Weight kg/1000	= 0.52
d5 min	= 1.7	Nominal drive	= 0.9		
Description = J 14		s	= 1.00		